



# MOMO-R Power P030 Fixture Guide



Indoor/Outdoor | Surface | Output up to 2850lm/m (869lm/ft)



## Key applications

- ✓ Ceiling
- ✓ Direct lighting
- ✓ Downlighting
- ✓ Exterior
- ✓ Interior
- ✓ Retail display
- ✓ Wall grazing
- ✓ Wet area

## Key features

- ✓ Custom lengths
- ✓ Constant Voltage (CV)
- ✓ Diffusion: spotting
- ✓ Glare control options
- ✓ IP44 moisture resistant
- ✓ IP67 waterproof
- ✓ Lens options

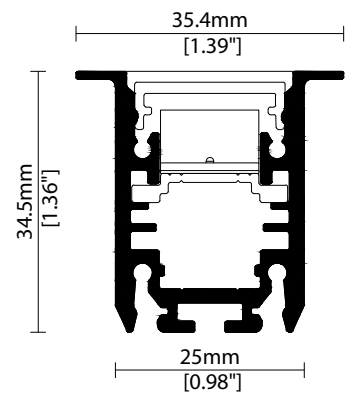

## MOUNTING METHODS



KKSB-01 Spring bracket

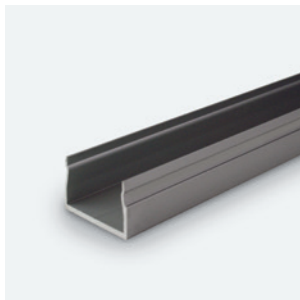

KKCR-01-1000 Cable raceway (1000mm)  
KKCR-01-2000 Cable raceway (2000mm)  
KKCR-01-3000 Cable raceway (3000mm)

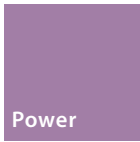

# MOMO-R Power P030

## Specification sheet



<b>Dimensions</b>	H34.5/W35.4/L265-2015mm (H1.36/W1.39/L10.24-79.13in)
<b>PCB Cut-point</b>	250mm increment/2000mm max (9.84in increment/78.74in max)
<b>LED Pitch</b>	35.7mm-28LED/m (1.40in - 8LED/ft)
<b>Chip</b>	<b>h-line</b>
<b>Cover/Optics</b>	Clear/12°/25°/60°/Spread lens/No lens/Micro louvre/Honeycomb louvre
<b>CCT</b>	<b>h-line:</b> 2700K, 3000K, 3500K, 4000K, 5000K
<b>LED binning</b>	<b>h-line:</b> 3-step MacAdam ellipse
<b>CRI</b>	≥94
<b>Lifetime</b>	50,000 hours @ 25°C (50,000 hours @ 77°F)
<b>Operating temp</b>	T <sub>a</sub> = -25 to 40°C (T <sub>c</sub> max = 76.4°C) T <sub>a</sub> = -13 to 104°F (T <sub>c</sub> max = 170°F)
<b>IP Rating</b>	IP44/67
<b>Finish</b>	Silver anodised
<b>Mounting</b>	Recessed mounting via spring clip / Cable race way
<b>Power feed</b>	Sheathed hardwire tails or male/female connectors
<b>Control</b>	0-10V/1-10V/DMX/DALI



### LED Grading Key

<b>Exclusive Grade</b>		<i>*KKDC tuned</i>
<b>h-line*</b>	Constant Voltage Lensed High Power LED	CCT range
	3-step CCT range	
	(4-step for 5000K)	

Power consumption	Supply voltage	Supply current
30W/m (9.14W/ft)	24V DC	1.25A/m (0.38A/ft)

### Performance Data (3000K)

h-line	R1	R2	R3	R4	R5	R6	R7	R8	R9	R10	R11	R12	R13	R14
h-line	95	98	99	96	95	98	93	84	63	94	98	88	96	99

	Clear + 12°	Clear + 25°	Clear + 60°	Clear + Spread	No lens	Clear Cover + Micro Louvre	Clear Cover + Honeycomb louvre	CRI	R9	Rf	Rg
h-line	2850lm/m (869lm/ft) 95lm/W	2760lm/m (841lm/ft) 92lm/W	2730lm/m (832lm/ft) 91lm/W	2400lm/m (731lm/ft) 80lm/W	2490lm/m (759lm/ft) 83lm/W	-60% Output when combined with Cover and Lens options	-40% Output when combined with Cover and Lens options	95	63	-	-

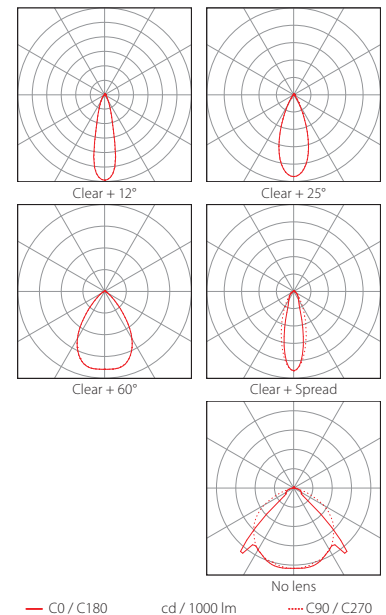
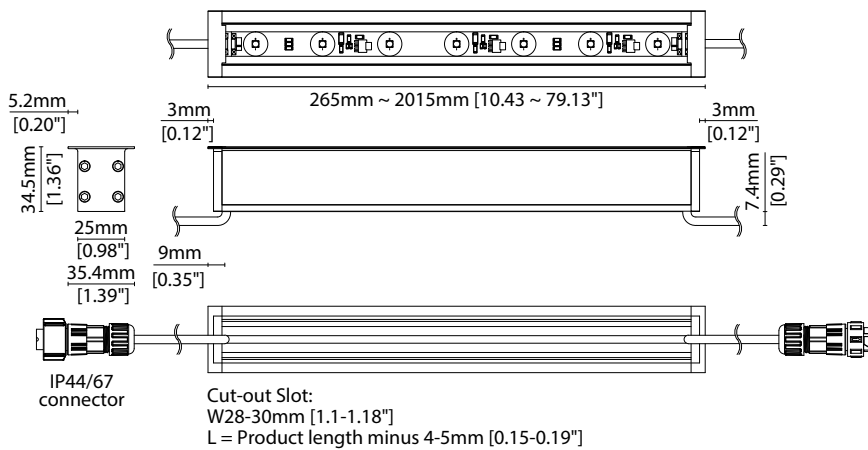

Data derived from production samples tested to UKAS/IESNA LM-79-08 standards.

# MOMO-R Power P030

## Code Table



### FIXTURE

Model	Finish	Cover/Lens <sup>1</sup>	Grade <sup>2</sup>	LED	Colour (CCT)	Length Availability <sup>3</sup>	IP	Cable Length	Power Feed <sup>4</sup>	Optics	Input									
MOMO-R Power	OR	Silver Anodised	SA	Clear	B	h	h	P030 P030	2700K 27	m	265-2015mm 250mm increments	IP44 44 IP67 <sup>5</sup> 67	300mm/ 11.81"	0300	Single ø4.3mm sheath tail	S00A	No lens	xx	DC 24V	g
		Clear+ Micro louvre	K	3000K 30											Double ø4.3mm sheath tail	D00A	12°	12		
		Clear+ Honeycomb louvre	Z	3500K 35		i					10.43-79.33in 9.84in increments				Single ø4.3mm sheath IP67 Male connector <sup>6</sup>	S67A	25°	25		
				4000K 40							(Specify length code OR total run length)				Double ø4.3mm sheath IP67 connector <sup>6</sup>	D67A	60°	60		
				5000K 50													Spread	SL		

<sup>1</sup> Refer to **Cover/Lens Options** on **Options** pages

<sup>2</sup> Refer to **LED Grading Key** on **Specification sheet** page

<sup>3</sup> Refer to **Length Availability List** or enter total run length instead of length code

<sup>4</sup> Refer to **Power Feed Options** on **Options** pages

<sup>5</sup> Due to the clear, flush potted polyurethane top layer on IP67 MOMO-R Power a colour shift of +/- 20K should be expected

<sup>6</sup> IP67 connectors are used for both IP67 and IP44 product housings

### Code Example:

OR	-	SA	-	B	-	h	-	P030	-	35	-	m	-	515	-	67	-	0300	-	D67A	-	xx	-	g
MOMO-R Power		Silver Anodised		Clear		h		P030		3500K		m		515mm		IP67		300mm/11.81"		Double ø4.3mm sheath IP67 connector		No lens		DC 24V

### ACCESSORIES

#### Mounting Accessories

KKSB-01	Spring bracket (allow 2 per metre/40")
KKCR-01-1000	1000mm/39.37" Cable Raceway
KKCR-01-2000	2000mm/78.74" Cable Raceway
KKCR-01-3000	3000mm/118.11" Cable Raceway

\* Refer to **Mounting accessories** on **Accessories** pages

#### Connection Accessories

CN67-2P-0300	IP67 2 PIN male & female 300mm/11.81" pair
CN67-2P-1000	IP67 2 PIN male & female 1000mm/39.37" pair
CN67-2P-3000	IP67 2 PIN male & female 3000mm/118.11" pair

\* Refer to **Power feed** on **Accessories** pages

#### Exterior Junction Boxes

KKJB-07	IP67 Slim J-Box
KKJB-07R	Potting Resin for IP67 Slim J-Box

\* Refer to **Exterior Junction Boxes** on **Accessories** pages

#### PSU/Driver

0-10V/1-10V/DALI/DMX

\* Refer to **Driver/PSU Options** page for details or provide requirement and KKDC to offer the suitable option

# MOMO-R Power P030

## Length Availability List



Length Code		Fixture Length <sup>1</sup>		LED Strip <sup>2</sup>		End Cap Dimension <sup>3</sup>		Wattage (W)	Output (lm)
Metric	Imperial(US)	Metric	Imperial(US)	Metric	Imperial(US)	Metric	Imperial(US)		3000K (Test Data)
m0265	i0011	265mm	10.43in	250mm	9.84in	15mm	0.59in	7.50	753
m0515	i0021	515mm	20.28in	500mm	19.69in	15mm	0.59in	15.00	1506
m0765	i0031	765mm	30.12in	750mm	29.53in	15mm	0.59in	22.50	2259
m1015	i0040	1015mm	39.96in	1000mm	39.37in	15mm	0.59in	30.00	3012
m1265	i0050	1265mm	49.80in	1250mm	49.21in	15mm	0.59in	37.50	3765
m1515	i0060	1515mm	59.65in	1500mm	59.06in	15mm	0.59in	45.00	4518
m1765	i0070	1765mm	69.49in	1750mm	68.90in	15mm	0.59in	52.50	5271
m2015	i0080	2015mm	79.33in	2000mm	78.74in	15mm	0.59in	60.00	6024

<sup>1</sup> Actual total overall length of light fixture (LED strip + end caps + void/wire hole)

<sup>2</sup> Actual length of PCB strip

<sup>3</sup> Actual length of 2x end caps

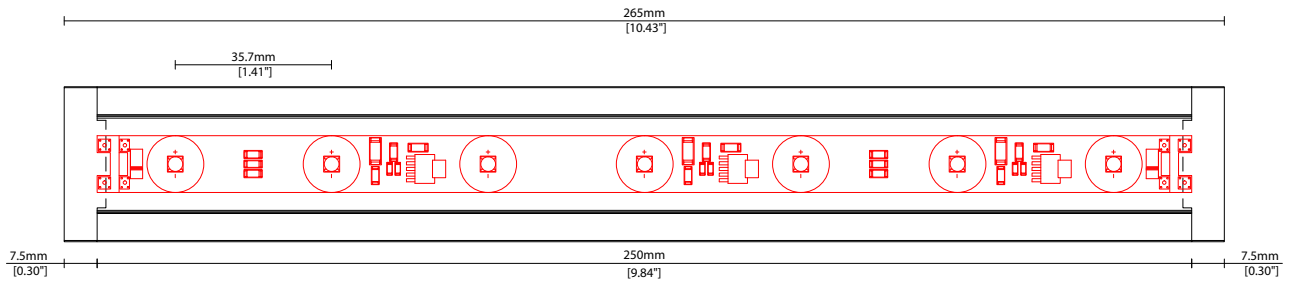

CUT-OUT SLOT:

W28-30mm (1.1-1.18")

L = Product length minus 4-5mm (0.15-0.19")

### COVER/LENS OPTIONS

\* Options are an integral part of the fixture ordering codes. Please refer to **Code Table** pages.



**B** Clear Cover

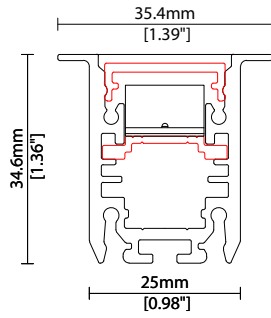

**K** Clear + Micro louvre

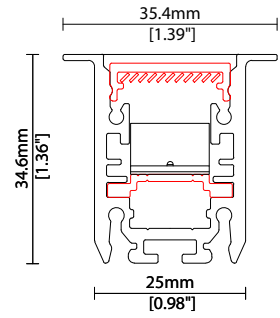

**Z** Clear + Honeycomb louvre

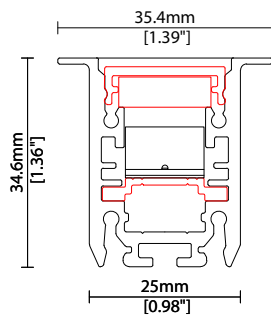

### POWER FEED OPTIONS

#### 0300 S00A 300mm (11.81") Single Ø4.3mm sheath tail

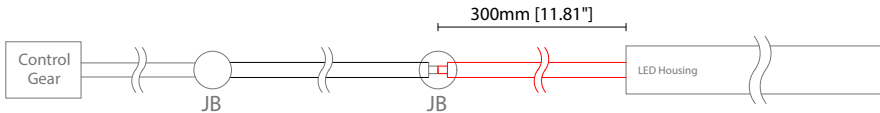

#### 0300 D00A 300mm (11.81") Double Ø4.3mm sheath tail

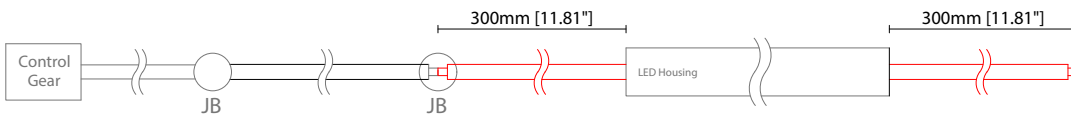

#### 0300 S67A 300mm (11.81") Single ø4.3mm sheath IP67 connector

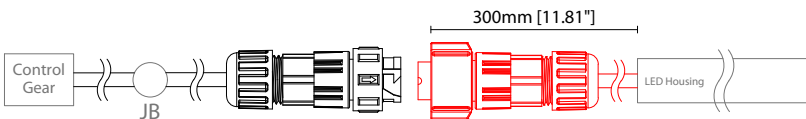

#### 0300 D67A 300mm (11.81") Double ø4.3mm sheath IP67 connector

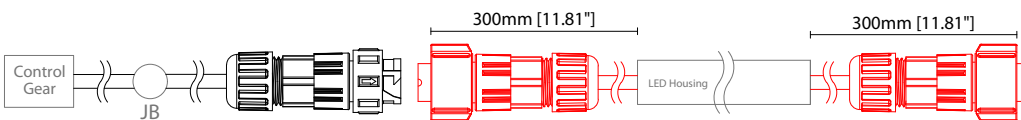

### IP67 2 Pin Connector

Female connector  
2 PIN (IP67)

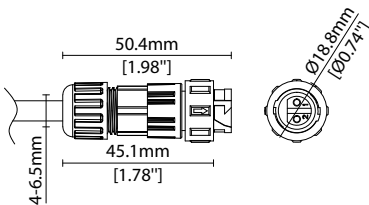

Male connector  
2 PIN (IP67)

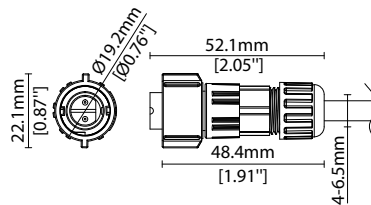

### Key

Control Gear Power supply, sub-controllers & control systems

JB Junction box / cable connection

### MOUNTING ACCESSORIES

Note: Accessories are to be ordered separately with corresponding code shown below.

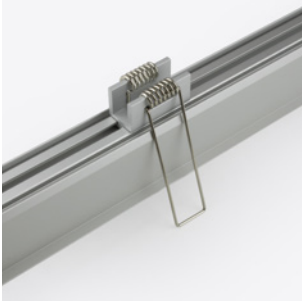

#### KKS-01

Spring bracket  
(allow 2 per metre/40")  
Anodised aluminium finish  
L31/W35.4/H45.2mm  
(L1.22/W1.39/H1.78")

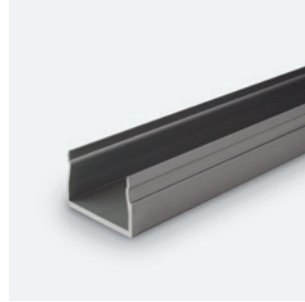
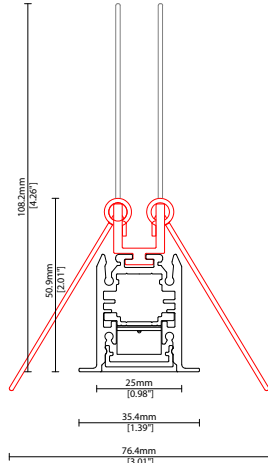

KKCR-01-1000 1000mm (39.37in)  
KKCR-01-2000 2000mm (78.74in)  
KKCR-01-3000 3000mm (118.11in)

Cable raceway\*  
anodised aluminium finish  
W22/H36.4mm (W0.87/H1.43")  
\* Cut & drilled to fit on site

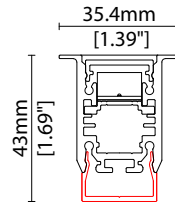

### POWER FEED

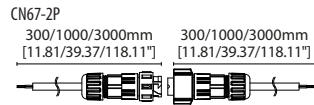

CN67-2P  
300/1000/3000mm [11.81/39.37/118.11"]  
300/1000/3000mm [11.81/39.37/118.11"]  
CN67-2P-0300 300mm (11.81in) pair  
CN67-2P-1000 1000mm (39.37in) pair  
CN67-2P-3000 3000mm (118.11in) pair

IP67

2 PIN male + female connector set

### EXTERIOR JUNCTION BOXES



**KKJB-07**

IP67 Slim J-Box  
(including type A,B,C, D bushings)



**KKJB-07R**

Potting resin for IP67 Slim J-Box

### KKDC CONTROL



**KKDM-06** 1-10V

visDIM dimmable sub-controller  
(4 x 8A max @ 12-36V)

IP20  
Plastic housing  
L170/W59/H29mm  
(L6.69/W2.32/H1.14in)



**KKSC-05** DMX

visDIM dimmable sub-controller  
(4 x 5A max @ 12-36V)

IP20  
Plastic housing  
L170/W53.4/H28mm  
(L6.69/W2.10/H1.10in)



**KKDL-02** DALI

visDIM dimmable sub-controller  
(4 x 8A max @ 12-36V)

IP20  
Plastic housing  
L170/W59/H29mm  
(L6.69/W2.32/H1.14in)



**KKDL-03** DALI

visDIM dimmable sub-controller  
(4 x 5A max @ 12-36V)

IP20  
Plastic housing  
L166/W53.4/H23mm  
(L6.54/W2.10/H0.91in)



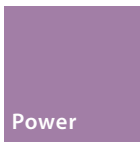

# MOMO Power P030

## Driver/PSU Options



### AVAILABLE PSU OPTIONS

Control Mode	PSU (Order Code)	Input Voltage AC	Output Voltage DC	Rated Output Current	Rated Power	Dim %	IP Rating
Switched	CEN-60-24	90-295V	24V	2.5A	60W	-	IP67
	HLG-60H-24	90-305V	24V	2.5A	60W	-	IP67
	HLG-100H-24	90-305V	24V	4.0A	100W	-	IP67
	HLG-150H-24	90-305V	24V	6.3A	150W	-	IP67
	HLG-240H-24	90-305V	24V	10A	240W	-	IP67
0-10V (1-10V)	PWM-40-24	90-305V	24V	1.67A	40W	100-0.15 (100-10)	IP67
	PWM-60-24	90-305V	24V	2.5A	60W	100-0.15 (100-10)	IP67
	PWM-90-24	90-305V	24V	3.67A	90W	100-0.15 (100-10)	IP67
	PWM-120-24	90-305V	24V	5.0A	120W	100-0.15 (100-10)	IP67
DALI	LIN100A1	120-277V	24V	1A per channel	100W	100-0.1	IP66/IP40
DMX RGB	LIN100A1	120-277V	24V	1.33A per channel	100W	100-0.1	IP66/IP40
DMX RGBW	LIN100A1	120-277A	24V	1A per channel	100W	100-0.1	IP66/IP40

### Flicker Free Options - Combination of PSU+ sub-controller

Control Mode	PSU (Order Code)	Sub-controller (Order Code)	Input Voltage AC	Output Voltage DC	Rated Output Current	Rated Power	Dim %	IP Rating PSU/ Sub-controller
0-10V or 1-10V	CEN-60-24	KKDM-06	90-295V	24V	2.5A	60W	100-0.9	IP67/IP20
	HLG-60H-24	KKDM-06	90-295V	24V	2.5A	60W	100-0.9	IP67/IP20
	HLG-100H-24	KKDM-06	90-295V	24V	4.0A	100W	100-0.9	IP67/IP20
	HLG-150H-24	KKDM-06	90-295V	24V	6.3A	150W	100-0.9	IP67/IP20
	HLG-240H-24	KKDM-06	90-295V	24V	10.0A	240W	100-0.9	IP67/IP20
DALI	CEN-60-24	KKDL-02/03	90-295V	24V	2.5A	60W	100-0.1	IP67/IP20
	HLG-60H-24	KKDL-02/03	90-305V	24V	2.5A	60W	100-0.1	IP67/IP20
	HLG-100H-24	KKDL-02/03	90-305V	24V	4.0A	100W	100-0.1	IP67/IP20
	HLG-150H-24	KKDL-02/03	90-305V	24V	6.3A	150W	100-0.1	IP67/IP20
	HLG-240H-24	KKDL-02/03	90-305V	24V	10.0A	240W	100-0.1	IP67/IP20
DMX RGB	CEN-60-24	KKSC-05	90-295V	24V	2.5A	60W	100-0.9	IP67/IP20
	HLG-60H-24	KKSC-05	90-305V	24V	2.5A	60W	100-0.9	IP67/IP20
	HLG-100H-24	KKSC-05	90-305V	24V	4A	100W	100-0.9	IP67/IP20
	HLG-150H-24	KKSC-05	90-305V	24V	6.3A	150W	100-0.9	IP67/IP20
	HLG-240H-24	KKSC-05	90-305V	24V	10.0A	240W	100-0.9	IP67/IP20

<sup>1</sup> The items shown above cover the most frequently used specification but does not exhaust the possible options

<sup>2</sup> PSU and/or driver can be chosen from the table, or KKDC may recommend the best option upon receipt of the controls requirement and installation environment

<sup>3</sup> Electrical shop drawing will include detailed information of PSU and relevant control drivers

<sup>4</sup> Cut sheets are available on the controls section of [www.kkdc.lighting](http://www.kkdc.lighting) or upon request